

SI-1249

LA-1249 Flex Ext. for SAM 60 pin QTH-QSH series 24.00

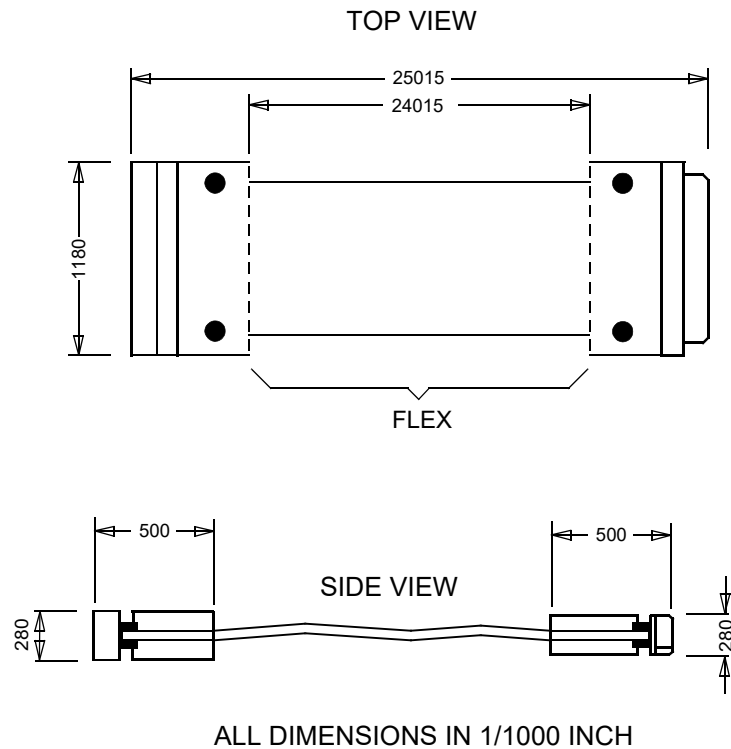

SI-1249

Technical Information