

In-Circuit Emulator for Renesas H8/300 and H8/500

H8/3006	H8/3334Y	H8/536R
H8/3007	H8/3334YF	H8/536S
H8/3060	H8/3336Y	H8/537
H8/3061	H8/3337Y	
H8/3062	H8/336	
H8/3064	H8/337	
H8/3065	H8/338	
H8/3066	H8/3394	
H8/3067	H8/3396	
H8/3101	H8/3397	
H8/3102	H8/3434	
H8/3202	H8/3434F	
H8/3212	H8/3436	
H8/3214	H8/3437	
H8/3216	H8/350	
H8/3217	H8/3640	
H8/322	H8/3641	
H8/323	H8/3642	
H8/324	H8/3643	
H8/325	H8/3644	
H8/3256	H8/3812	
H8/3257	H8/3813	
H8/326	H8/3833	
H8/327	H8/3834	
H8/328	H8/3835	
H8/329	H8/3836	
H8/3292	H8/3837	
H8/3294	H8/520	
H8/3296	H8/532	
H8/3297	H8/534R	
H8/330	H8/534S	

- Support for 300, 300H and 500 family
- Support for 5V and 3.3V
- Full bondout support
- Up to 20MHz support
- On chip ROM and FLASH emulation
- Banking up to 16MByte (256 banks)
- Dual ported memory
- Software compatible ROM Monitor
- Interface with all compilers
- RTOS support
- CASE tool interface
- Windows9x, NT and X windows interface

TRACE32-ICEH8 supports most members of the H8 family from Renesas. The modular and open technology of the system allows the fast integration of new chip designs.

TRACE32-ICE is a state of the art In-Circuit Emulator, which offers unlimited hardware breakpoints and up to 16MByte dual-ported emulation memory. The real-time trace and trigger work up to the max. speed of the CPU. The analyzer offers selective trace as well as performance analysis and statistic functions.

The system offers an interface to all C and C++ compilers. Full RTOS support is available for HIOS/Renesas and Nucleus PLUS from Accelerated Technology.

TRACE32 works with the highest variety of host interfaces. The communication link to the host is done by the printer port, a fibre optic interface or ethernet allowing a high speed transfer.

Features

Basics of Operation

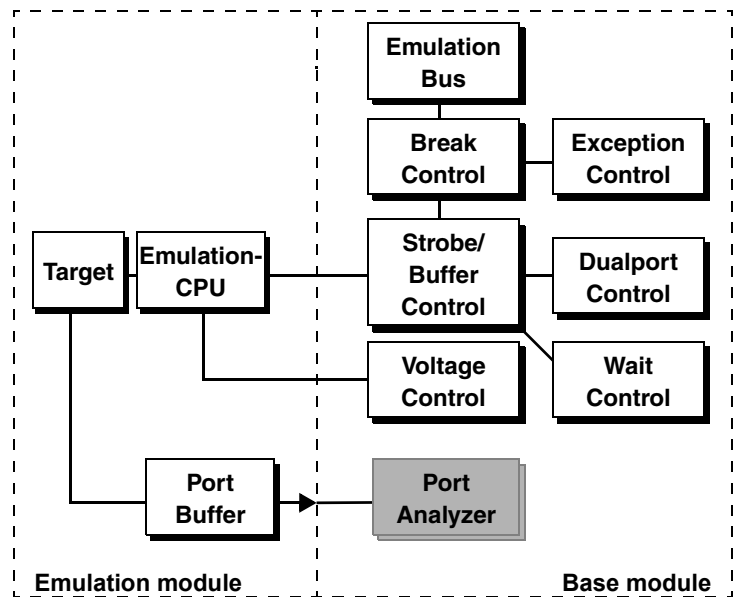

The ICE H8 probe is a high-performance emulation system for many derivatives of the H8 family. The change between different CPU types is done by changing the emulation module.

On the emulation base there is an extra slot for the TRACE32 Port Analyzer which can trace up to 64 port lines.

Operating Modes

The Emulator can work in stand-alone mode with internal clock or in active mode with internal or the target clock. On power-down of the target system the emulator tristates its output buffers and isolates its internal emulation circuits.

The operation modes are as follows:

- Reset Down
- Reset Up
- No Probe
- Alone Internal
- Alone External
- Emulation Internal
- Emulation External

Clock

- Operation with external or internal clock

- Max. operation frequency:
20 MHz

Clock Fail Detection

Support for all Operation Modes

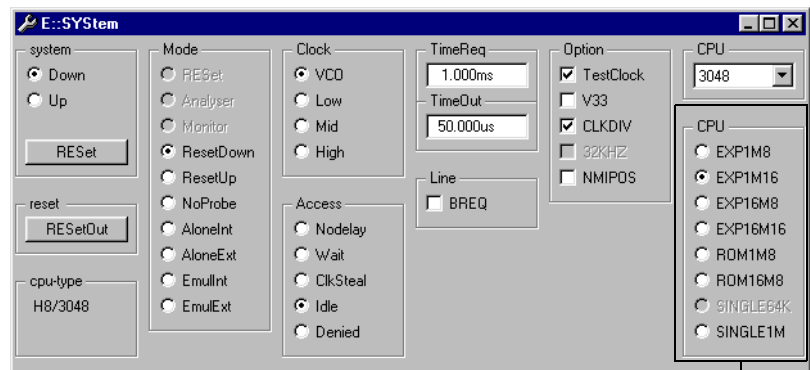

Operation modes

ICE-H8 supports the realtime emulation of all operations modes at max. speed.

Dual-port Access

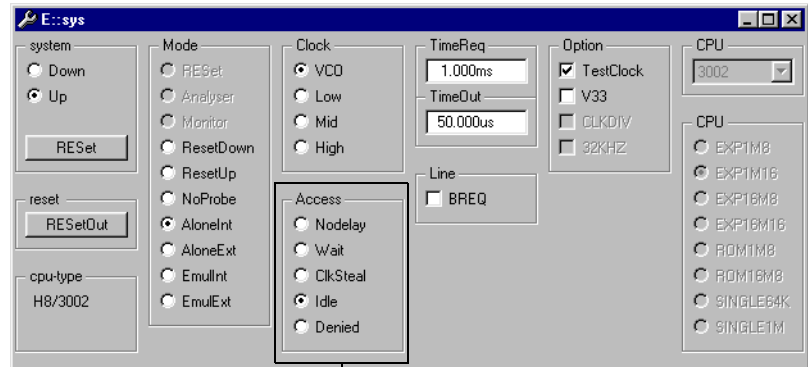

Dual port access modes

All TRACE32 memories are dual-ported. The dual-port access makes it possible to display and modify the contents of the overlay memory, to set or delete breakpoints or use the flag memory while the application is running in real-time.

The H8 has four dual-port modes:

- Nodelay
- Wait
- ClkSteal
- Idle

In **Nodelay** mode, the dual-port access is inserted in the regular bus cycles, generated by the CPU. This means that the CPU runs in real time during the dual-port access.

In **Wait** mode, wait states are inserted for the dual-port access via the wait pin. This is only possible, if the corresponding pins is configured as the wait pin.

In **ClkSteal** mode, the CPU clock is stopped for some cycles during the dual-port access. This works only if the emulator uses the internal VCO clock.

In **Idle** mode, the emulator waits on idle cycles of the CPU to perform the dual-port access. This cycles are generated for example during subroutine jumps.

In the **Denied Mode** the dual-port access is switched off.

Peripheral Information

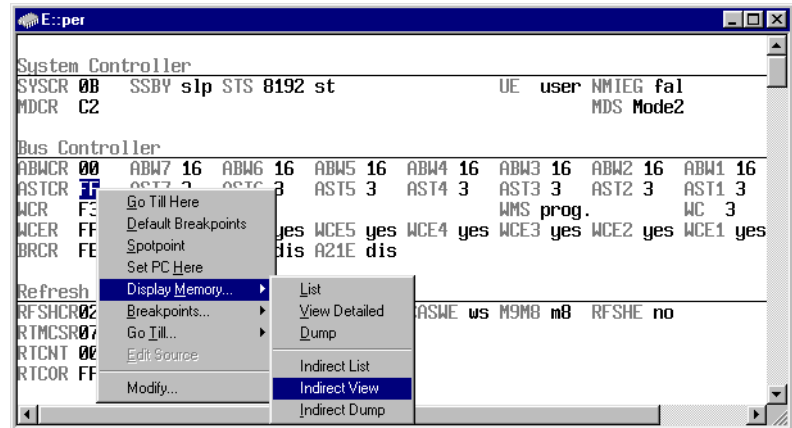

- Display of onchip peripherals
- User definable display of the onchip peripherals
- Definition is done interactive supported by softkeys
- Pull down menus for settings
- Additional description for each field
-

Exception Control

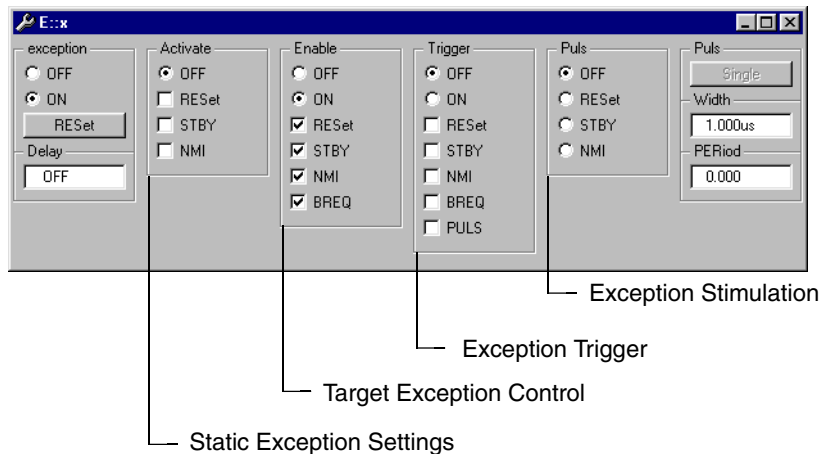

The TRACE32 exception controller allows to permanently activate an exception, to enable or disable specific

exceptions, to trigger on specific exceptions or to stimulate an exception.

HLL Debugging

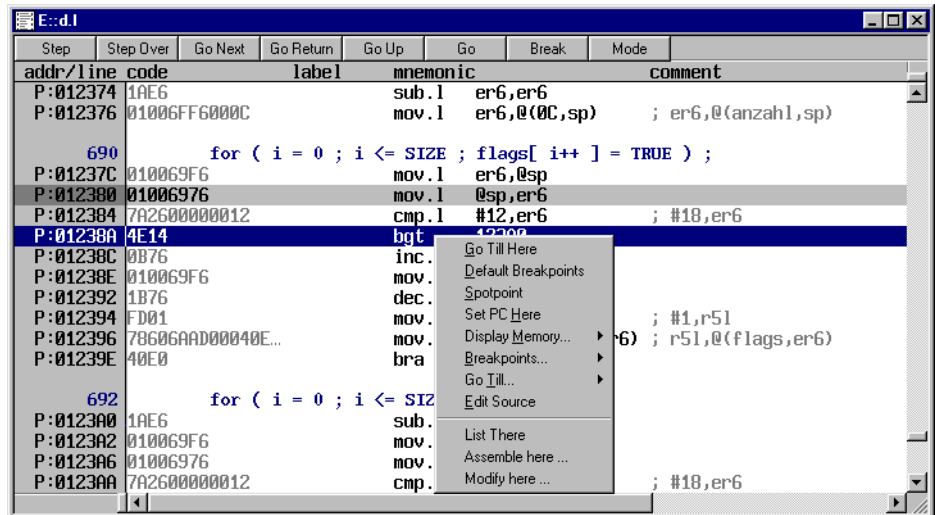

Full support in real-time for:

- Break-before-line operation
- HLL single step in real-time

Trigger and trace on local variables

Background Task

The background task allows:

- To process interrupts

To maintain the refresh of a target DRAM while the emulation is stopped.

Peripheral Window

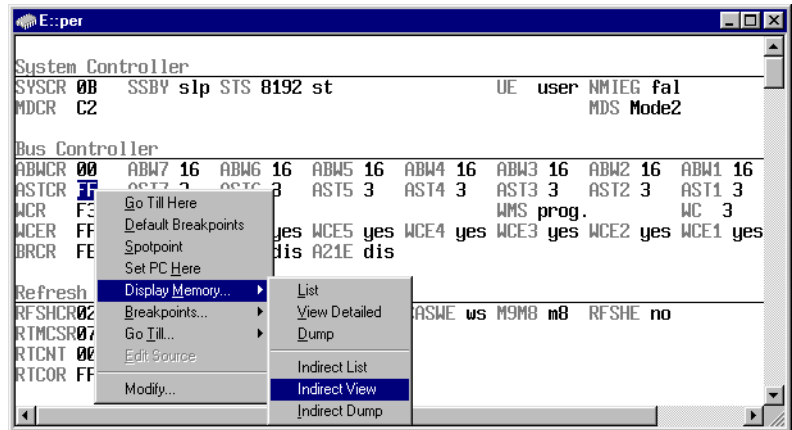

- Display of onchip peripherals
- User definable display of the onchip peripherals
- Definition is done interactive supported by softkeys
- Pull down menus for settings
- Additional description for each field
-

Memory Banking (H8/300 only)

ICE-H8 supports up to 256 banks for internal or external banking:

- Support for paged EPROMS
- Support for external banking using a CPU register or a CPU output pin. For external banking a separate banking probe is needed.

Emulation Modules

Modules Overview

tbd

Debug Interfaces

TRACE32-PowerView supports most compilers, realtime operation systems and debuggers.

New integrations are mostly done on customers request. If your compiler or RTOS is not supported now, please ask us !

Compiler H8300

CPU	Language	Compier	Compan y	Option
H8/300	C	GNU-C	Free Software Foundati on, Inc.	COFF
H8/300	C	ICCH8300	IAR Systems AB	UBROF
H8/300	C	MCCH83	Mentor Graphics Corporati on	IEEE
H8/300	C	CH38	Renesas Technolo gy, Corp.	SYSROF
H8/300	C++	GNU-C++	Free Software Foundati on, Inc.	COFF

Compiler H8/300H

CPU	Language	Compiler	Company	Option
H8/300H	C	GNU-C	Free Software Foundation, Inc.	COFF
H8/300H	C	IARH8	IAR Systems AB	UBROF
H8/300H	C	CH38	Renesas Technology, Corp.	SYSROF
H8/300H	C++	GNU-C++	Free Software Foundation, Inc.	COFF

Compiler H8500

CPU	Language	Compiler	Company	Option
H8/500	C	ICCH8500	IAR Systems AB	UBROF
H8/500	C	MCCH85	Mentor Graphics Corporation	IEEE
H8/500	C	HICROSS-H8/500	NXP Semiconductors	HICROSS

RTOS Support

Company	Product	Comment
CMX Systems Inc.	CMX-RTX	
Renesas Technology, Corp.	HIOS	(HI8-3H), not supported in EUR
Mentor Graphics Corporation	Nucleus	
-	OSEK	via ORTI
Elektrobit Automotive GmbH	ProOSEK	via ORTI

Debugger Support

CPU	Debugger	Company
	WINDOWS CE PLATF. BUILDER	-
	CODE::BLOCKS	-
	C++TEST	-
	ADENEO	-
	X-TOOLS / X32	blue river software GmbH
	CODEWRIGHT	Borland Software Corporation
	CODE CONFIDENCE TOOLS	Code Confidence Ltd
	CODE CONFIDENCE TOOLS	Code Confidence Ltd
	EASYCODE	EASYCODE GmbH
	ECLIPSE	Eclipse Foundation, Inc

CPU	Debugger	Company
	CHRONVIEW	Inchron GmbH
	LDRA TOOL SUITE	LDRA Technology, Inc.
	UML DEBUGGER	LieberLieber Software GmbH
	SIMULINK	The MathWorks Inc.
	ATTOL TOOLS	MicroMax Inc.
	VISUAL BASIC INTERFACE	Microsoft Corporation
	LABVIEW	NATIONAL INSTRUMENTS Corporation
	RAPITIME	Rapita Systems Ltd.
	RHAPSODY IN MICROC	IBM Corp.
	RHAPSODY IN C++	IBM Corp.
	DA-C	RistanCASE
	TRACEANALYZER	Symtavision GmbH
	TA INSPECTOR	Timing Architects GmbH
	UNDODB	Undo Software
	VECTORCAST UNIT TESTING	Vector Software
	VECTORCAST CODE COVERAGE	Vector Software

Operation Frequency

The maximum operation frequency of TRACE32-ICEH8 depends on:

- The max. frequency of the CPU
- The access time of the overlay memory (15ns or 35ns)
- The mapper mode (**S**low or **F**ast)
- The number of waitstates
(W0 = 0 waitstates
W1 = 1 waitstate)
- The dual-port access mode

Idle Access

Dimensions

Module Dimensions

tbd

Connectors

On each emulation module there are half-size connectors to:

- ❑ Connect the emulation module directly to the target by providing the corresponding connectors also on the target hardware

- ❑ Connect a standard adapter from Emulation Technologie, YAMAICHI, AMP etc.

The following table lists the physical dimensions of these half size connectors.
tbd

Adapter

The adapters connect in different ways

- With Clip-Over Adapters the CPU can stay on the target board.
- With Solder-ON adapters the CPU must be removed

- YAMAICHI and AMP adapters fit to the CPU socket

The following table lists the physical dimensions of these adapters.

Not necessary.

Available Tool Chain

TRACE32 provides a complete set of development tools for the H8 family. This includes:

- The In-Circuit Emulator TRACE32-ICE
- The ROM Monitor based In-Circuit Debugger TRACE32-ICD

- Evaluation boards, which can be used until the target hardware is available.

The following list give an overview which development tools are available for the specific derivatives of the H8-family.
tbd

Order Information

Module Description

Detailed Order Information

Contact

International Representative

Argentina

Anacom Eletronica Ltda.
Mr. Rafael Sorice
Rua Nazareth, 807, Barcelona
BR-09551-200 São Caetano do Sul, SP
Phone: +55 11 3422 4200
FAX: +55 11 3422 4242
EMAIL: rsorice@anacom.com.br

Australia

Embedded Logic Solutions P/L
Mr. Ramzi Kaffan
Suite 2, Level 3
144 Marsden Street
Parramatta NSW 2150
Phone: +61 2 9687 1880
FAX: +61 2 9687 1881
EMAIL: sales@emlogic.com.au

Austria

Lauterbach GmbH
Altlaufstr. 40
D-85635 Höhenkirchen-Siegertsbrunn
Phone: +49 8102 9876 0
FAX: +49 8102 9876 999
EMAIL: info@lauterbach.com

Belgium

Tritec Benelux B.V.
Mr. Robbert de Voogt
Stationspark 550
NL-3364 DA Slidrecht
Phone: +31 184 41 41 31
FAX: +31 184 42 36 11
EMAIL: software@tritec.nl

Brazil

Anacom Eletronica Ltda.
Mr. Rafael Sorice
Rua Nazareth, 807, Barcelona
BR-09551-200 São Caetano do Sul, SP
Phone: +55 11 3422 4200
FAX: +55 11 3422 4242
EMAIL: rsorice@anacom.com.br

Canada

Lauterbach Inc.
Mr. Udo Zoettler
4 Mount Royal Ave.
USA-Marlborough, MA 01752
Phone: +1 508 303 6812
FAX: +1 508 303 6813
EMAIL: info_us@lauterbach.com

China Beijing

Lauterbach Technologies Co., Ltd
Mr. Linglin He
Beijing Office
A3, South Lishi Road, XiCheng District
Beijing 100037, P.R. China
Phone: +86 10 68023502
FAX: +86 10 68023523
EMAIL: linglin.he@lauterbach.com

China Shenzhen

Lauterbach Technologies Co., Ltd
1406/E Xihaimingzhu Building
No.1 Taoyuan Road, Nanshan District
Shenzhen 518052, P.R. China
Phone: +86 755 8621 0671
FAX: +86 755 8621 0675
EMAIL: emily.zhang@lauterbach.com

China Suzhou

Lauterbach Technologies Co., Ltd
Mr. Linglin He
Hengyu Square, Rm 709
No. 188, Xing Hai Street
Suzhou, 215021 P.R. of China
Phone: +86 512 6265 8030
FAX: +86 512 6265 8032
EMAIL: info_cn@lauterbach.com

Czech Republic

Lauterbach GmbH
Altlaufstr. 40
D-85635 Höhenkirchen-Siegertsbrunn
Phone: +49 8102 9876 0
FAX: +49 8102 9876 999
EMAIL: info@lauterbach.com

Denmark

Nohau Danmark A/S
Mr. Flemming Jensen
Klausdalsbrovej 493
DK-2730 Herlev
Phone: +45 44 52 16 50
FAX: +45 44 52 26 55
EMAIL: info@nohau.dk

Egypt

Wantech Egypt
Mr. Wagih A. Nawara
5 Shafik Ghalie St., Suite 2
Off Pyramids Road, Giza
Cairo 12111
Phone: +20 100 1251955
FAX: +20 100 1250349
EMAIL: sales@wantech.net.com

Finland

Nohau Solutions Finland
Mr. Martti Viljainen
Teknobulevardi 3-5
FI-01531 Vantaa
Phone: +358 40 546 1469
FAX: +358 9 2517 8101
EMAIL: sales@nohau.fi

France

Lauterbach S.A.R.L.
Mr. Jean-Pierre Paradiso
Europarc - Le Hameau B
135 Chemin Des Bassins
F-94035 Créteil Cedex
Phone: +33 1 49 56 20 30
FAX: +33 1 49 56 20 39
EMAIL: info_fr@lauterbach.com

Germany

Lauterbach GmbH
Altlaufstr. 40
D-85635 Höhenkirchen-Siegertsbrunn
Phone: +49 8102 9876 0
FAX: +49 8102 9876 999
EMAIL: info@lauterbach.com

Germany North

Lauterbach GmbH
Mr. Klaus Hommann
Leonhardring 5
D-31319 Sehnde
Phone: +49 8102 9876 174
FAX: +49 5138 6185 3
EMAIL: klaus.hommann@lauterbach.com

Germany South

Lauterbach GmbH
 Andreas Grimm
 Altlaufstr. 40
 D-85635 Höhenkirchen-Siegertsbrunn
 Phone: +49 8102 9876 190
 FAX: +49 8102 9876 187
 EMAIL: andreas.grimm@lauterbach.com

Greece

Lauterbach GmbH
 Altlaufstr. 40
 D-85635 Höhenkirchen-Siegertsbrunn
 Phone: +49 8102 9876 0
 FAX: +49 8102 9876 999
 EMAIL: info@lauterbach.com

Hungary

Lauterbach GmbH
 Altlaufstr. 40
 D-85635 Höhenkirchen-Siegertsbrunn
 Phone: +49 8102 9876 0
 FAX: +49 8102 9876 999
 EMAIL: info@lauterbach.com

India-Bangalore

Electro Systems Associates Pvt. Ltd.
 Mr. G. V. Gurunatham
 S-606, World Trade Center
 Malleswaram West, No.26/1, Dr. Rajkumar
 Road
 India - Bangalore 560055
 Phone: +91 80 67648888
 FAX: +91 80 23475615
 EMAIL: Trace32sales@esaindia.com

India-Chennai

Electro Systems Associates Pvt. Ltd.
 Mr. D. Kannan
 No.109/59A, Ground Floor
 IV Avenue, Ashok Nagar
 India - Chennai - 600 083 Tamilnadu
 Phone: +91 044-24715750
 FAX: +91 44 24715750
 EMAIL: chennai@esaindia.com

India-Delhi

Electro Systems Associates Pvt. Ltd.
 Mr. R.K. Bhandari
 No. 705, 7th Floor, Laxmi Deep
 Shivajinagar
 India - Delhi - 110 092
 Phone: +91 11-22549351
 FAX:
 EMAIL: delhi@esaindia.com

India-Hyderabad

Electro Systems Associates Pvt. Ltd.
 Mr. C.V.M. Sri Ram Murthy
 Shop No. 14, "Global Enclave"
 Bhagyannagar Colony, Kukat pally
 India - Hyderabad 500 072
 Phone: +91 40-23063346
 FAX: +91 40-23063346
 EMAIL: hyderabad@esaindia.com

India-Pune

Electro Systems Associates Pvt. Ltd.
 Mr. R K Bhandari
 Shriram Complex, 1126/1, Model Colony
 Shivajinagar
 India - Pune - 411 016
 Phone: +91 20 - 30462035 / 25663
 FAX: +91 20-25677202
 EMAIL: pune@esaindia.com

Ireland

Lauterbach Ltd.
 Mr. Barry Lock
 11 Basepoint Enterprise Centre
 Stroudley Road
 Basingstoke, Hants RG24 8UP
 Phone: +44-1256-333-690
 FAX: +44-1256-336-661
 EMAIL: info_uk@lauterbach.com

Israel

Itec Ltd.
 Mr. Mauri Gottlieb
 P.O. Box 10002
 IL-Tel Aviv 61100
 Phone: +972 3 6491202
 FAX: +972 3 6497661
 EMAIL: general@itec.co.il

Italy

Lauterbach Srl
 Mr. Maurizio Menegotto
 Via Enzo Ferrieri 12
 I-20153 Milano
 Phone: +39 02 45490282
 FAX: +39 02 45490428
 EMAIL: info_it@lauterbach.com

Japan

Lauterbach Japan, Ltd.
 Mr. Kenji Furukawa
 3-8-8 Shinyokohama
 Kouhoku-ku, Nisso 16th Building
 Yokohama-shi, Japan 222-0033
 Phone: +81 45 477 4511
 FAX: +81 45 477 4519
 EMAIL: info@lauterbach.co.jp

Luxembourg

Tritec Benelux B.V.
 Mr. Robbert de Voogt
 Stationspark 550
 NL-3364 DA Sliedrecht
 Phone: +31 184 41 41 31
 FAX: +31 184 42 36 11
 EMAIL: software@tritec.nl

Malaysia

Flash Technology
 Mr. Teo Kian Hock
 No 61, # 04-15 Kaki Bukit Av 1
 Shun Li Industrial Park
 SGP-Singapore 417943
 Phone: +65 6749 6168
 FAX: +65 6749 6138
 EMAIL: teokh@flashtech.com.sg

Mexico

Lauterbach Inc.
 Mr. Udo Zoettler
 4 Mount Royal Ave.
 USA-Marlborough, MA 01752
 Phone: +1 508 303 6812
 FAX: +1 508 303 6813
 EMAIL: info_us@lauterbach.com

Netherlands

Tritec Benelux B.V.
 Mr. Robbert de Voogt
 Stationspark 550
 NL-3364 DA Sliedrecht
 Phone: +31 184 41 41 31
 FAX: +31 184 42 36 11
 EMAIL: software@tritec.nl

New Zealand

Embedded Logic Solutions P/L
 Mr. Ramzi Kattan
 Suite 2, Level 3
 144 Marsden Street
 Parramatta NSW 2150
 Phone: +61 2 9687 1880
 FAX: +61 2 9687 1881
 EMAIL: sales@emlogic.com.au

Norway

Nohau Solutions AB
 Mr. Jörgen Nilsson
 Derbyvägen 4
 SE-21235 Malmö
 Phone: +46 40 592 206
 FAX: +46 40 592 229
 EMAIL: sales@nohau.se

Poland

QUANTUM Sp. z o.o.
 Mr. Aleksander Bil
 ul. Jeleniogorska 6
 54-056 Wrocław
 Phone: +48 71 362 6356
 FAX: +48 71 362 6357
 EMAIL: info@quantum.com.pl

Portugal

Captura Electronica, SCCL
Mr. Juan Martinez
c/Duero, 40
E-08031 Barcelona
Phone: +34 93 429 5730
FAX: +34 93 407 0778
EMAIL: info@captura-el.com

Romania

Lauterbach GmbH
Altlaufstr. 40
D-85635 Höhenkirchen-Siegersbrunn
Phone: +49 8102 9876 0
FAX: +49 8102 9876 999
EMAIL: info@lauterbach.com

Russia

RTSoft
Mr. Alexey Isaev
Nikitinskaya 3
RUS-105037 Moscow
Phone: +7 495 742 6828
FAX: +7 495 742 6829
EMAIL: sales@rtsoft.msk.ru

Singapore

Flash Technology
Mr. Teo Kian Hock
No 61, # 04-15 Kaki Bukit Av 1
Shun Li Industrial Park
SGP-Singapore 417943
Phone: +65 6749 6168
FAX: +65 6749 6138
EMAIL: teokh@flashtech.com.sg

South Korea, Pangyo

MDS Technology Co., Ltd.
Mr. Sangheon Lee
3FL, Hancom Tower
49, Daewangpangyo-ro 644, Bundang-gu
Seongnam-si, Gyeonggi-do, 463-400, ROK
Phone: +82-31-627-3000
FAX: +82-31-627-3100
EMAIL: trace32@mdstec.com

Spain

Captura Electronica, SCCL
Mr. Juan Martinez
c/Duero, 40
E-08031 Barcelona
Phone: +34 93 429 5730
FAX: +34 93 407 0778
EMAIL: info@captura-el.com

Sweden

Nohau Solutions AB
Mr. Jörgen Nilsson
Derbyvägen 4
SE-21235 Malmö
Phone: +46 40 592 206
FAX: +46 40 592 229
EMAIL: sales@nohau.se

Switzerland

JDT Jberg DatenTechnik
Mr. Andreas Jberg
Zimmereistrasse 2
CH-5734 Reinach AG
Phone: +41 62 7710 886
FAX:
EMAIL: Andreas.Jberg@jdt.ch

Taiwan

Superlink Technology Corp.
Mr. Sulin Huang
3F-8, No. 77, Sec. 1, Xintaiwu Rd., Xizhi District,
New Taipei City 22101, Taiwan, R.O.C.
Phone: +886 2 26983456
FAX: +886 2 26983535
EMAIL: info.stc@superlink.com.tw

Tunisia

Lauterbach Consulting S.A.R.L.
Mr. Khaled Jmal
Route El Ain Km 3.5
TN-3062 Sfax
Phone: +216-74611730
FAX: +216-74611723
EMAIL: info_tn@lauterbach.com

Turkey-1

Tektronik Muh. ve Tic. A.S.
Mr. Hakan Yavuz
CyberPlaza B-Blok, 702B
Bilkent
06800 Ankara
Phone: +90 312 437 3000
FAX: +90 312 437 1616
EMAIL: info@tektronik.com.tr

Turkey-2

G3TEK Embedded Technologies Ltd.
Mr. Celal Aygun
Ilkyerlesim Mah. 445.
Sok. No: 48
06370 Batikent/Ankara
Phone: +90 312 3324769
FAX: +90 312 3324769
EMAIL: info@g3tek.com

UK

Lauterbach Ltd.
Mr. Barry Lock
11 Basepoint Enterprise Centre
Stroudley Rd
Basingstoke, Hants RG24 8UP
Phone: +44 1256 333 690
FAX: +44 1256 350 301
EMAIL: info_uk@lauterbach.com

USA East

Lauterbach Inc.
Mr. Udo Zoettler
4 Mount Royal Ave.
USA-Marlborough, MA 01752
Phone: +1 508 303 6812
FAX: +1 508 303 6813
EMAIL: info_us@lauterbach.com

USA West

Lauterbach Inc.
Mr. Bob Kupyn
1111 Main Street, Suite 620
USA-Vancouver, WA, 98660
Phone: +1 503 524 2222
FAX: +1 503 524 2223
EMAIL: bob.kupyn@lauterbach.com

Additional Information

<http://www.lauterbach.com>

Lauterbach GmbH

Altlaufstr. 40
D-85635 Höhenkirchen-Siegertsbrunn
Tel. ++49 8102 9876-0 FAX -999
info@lauterbach.com
http://www.lauterbach.de

Lauterbach Inc.

4 Mount Royal Ave.
Marlboro MA 01752
Phone (508) 303 6812 FAX (508) 303 6813
info_us@lauterbach.com
http://www.us.lauterbach.com

Lauterbach Ltd.

11 Basepoint Enterprise Ctre Stroudley Road
Basingstoke, Hants RG24 8UP
Phone ++44-1256-333-690 FAX -661
info_uk@lauterbach.com
http://www.lauterbach.co.uk

Lauterbach S.A.R.L.

135 Chemin Des Bassins
F-94035 Créteil Cedex
Phone ++33-149-562-030
FAX ++33-149-562-039
info_fr@lauterbach.com
http://www.lauterbach.fr

Lauterbach Japan, Ltd.

3-9-5 Shinyokohama Kouhoku-ku
Yokohama-shi Japan 222-0033
Phone ++81-45-477-4511 FAX -4519
info_j@lauterbach.com
http://www.lauterbach.co.jp

Lauterbach s.r.l.

Lauterbach s.r.l.
Via Enzo Ferrieri 12
I-20153 Milano
Phone ++39 02 45490282
FAX ++39 02 45490428
info_it@lauterbach.it
http://www.lauterbach.it

Suzhou Lauterbach Consulting Co.,Ltd.

Room 1605, Xing Hai International Square
No.200, Xing Hai Street
Suzhou, 215021 PR of China
Phone: 0086-512 6265 8030
FAX: 0086-512 6265 8032
info_cn@lauterbach.cn
http://www.lauterbach.cn

Disclaimer

The information presented is intended to give overview information only. Changes and technical enhancements or modifications can be made without notice.